

TS1500-100

Transnorm Belt Curve Conveyor

Conveyor shown with optional floor supports

The Model TS1500-100 provides a positive flow of products by means of a belt, driven by tapered pulleys. Conveyor is versatile in that it can transport a wide variety of products. Available in 45°, 60°, 90°, and 180° turns. Other degrees available. Contact Transnorm.

- 5 Belt Widths
 - Adjustable FSK-Type Floor Supports Available
- F.O.B. Arlington, Texas

transnorm
your best move



OAW Frame	Conveying Surface Width	Belt Width	"IR"	"CL" Radius (CS)	"OR"	45° Weight (Lbs.)	60° Weight (Lbs.)	90° Weight (Lbs.)	180° Weight (Lbs.)
16 1/2"	11"	10"	34"	39 1/2"		361	386	411	552
18 1/2"	13"	12"	32"	38 1/2"		365	390	414	567
20 1/2"	15"	14"	30"	37 1/2"	45"	365	390	415	572
22 1/2"	17"	16"	28"	36 1/2"		367	392	417	577
24 1/2"	19"	18"	26"	35 1/2"		369	394	419	581

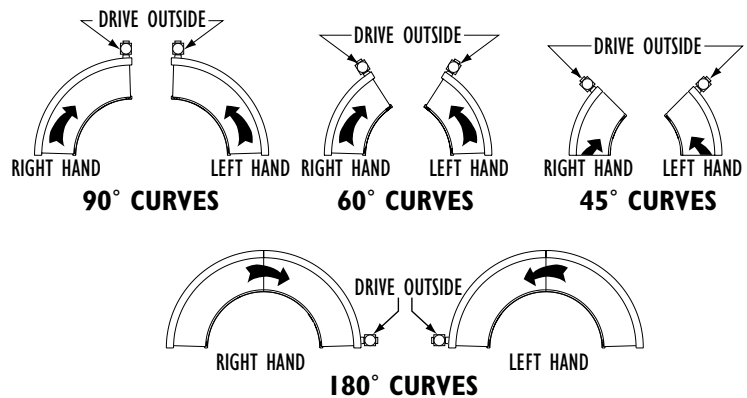
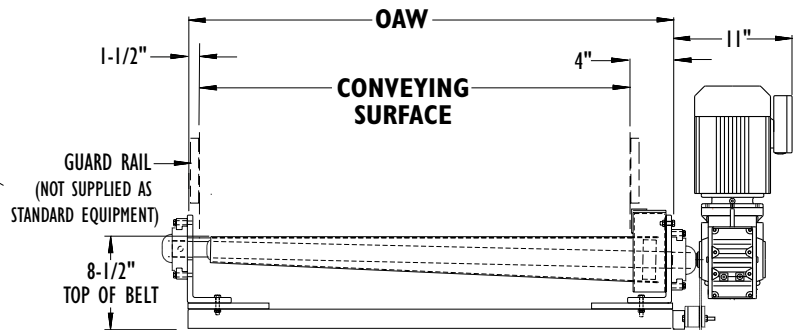
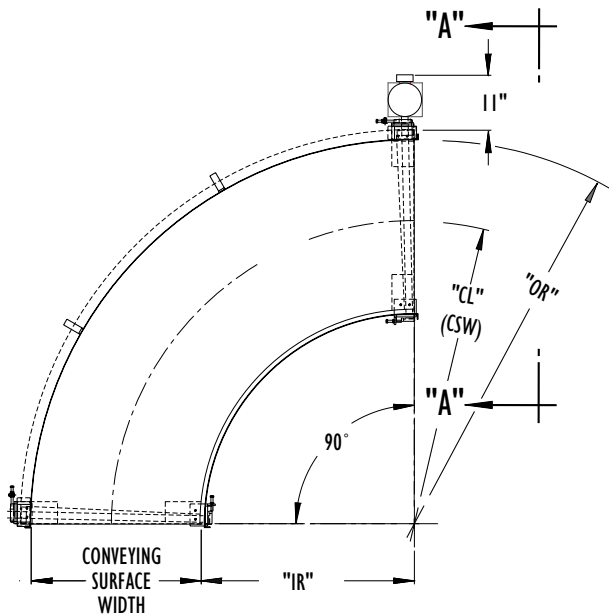

• STANDARD SPECIFICATIONS

BELT—Black Monofilament, PVC top with urethane guide strip.

FRAME—8.47 in. deep x 2" x 2" x 3/16" Structural Steel All Welded Construction.

PULLEYS—Tapered with 1 7/16 in. dia. shaft through bearings. Adjustable to control belt tension.

BEARINGS—Sealed, pre-lubricated, self-aligning, ball bearings on drive and tail pulley. Re-lube type.

MOTOR— 3/4 HP Shaft Mounted Right Angle Gearmotor 208/230/460/575V-3Ph. 60 Hz (Specify Exact Voltage).

BELT SPEED—Constant 65 FPM at center line of conveying surface.

CAPACITY—Maximum load per linear foot (measured at center line of conveying surface) 40 lbs.

FLOOR SUPPORTS—Now supplied as optional equipment. See chart below for available elevations.

FSK SUPPORT		
Model No.	OAW	Adjustment to Top of Belt
FSK-1	16 1/2" to 24 1/2"	9 1/2" - 24"
FSK-2		24" - 30"
FSK-3		30" - 36"
FSK-4		36" - 42"
FSK-5		42" - 48"
FSK-6		48" - 54"

For elevations above 54", contact factory.

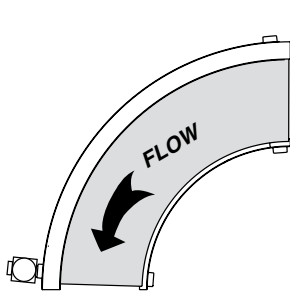

TYPE A
LEFT HAND CURVE
OUTSIDE DRIVE

STANDARD

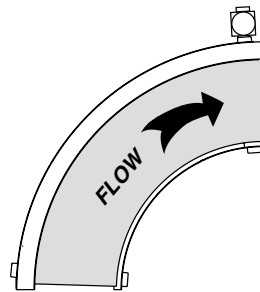

TYPE B
RIGHT HAND CURVE
OUTSIDE DRIVE

STANDARD

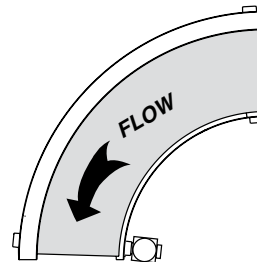

TYPE C
LEFT HAND CURVE
INSIDE DRIVE

STANDARD

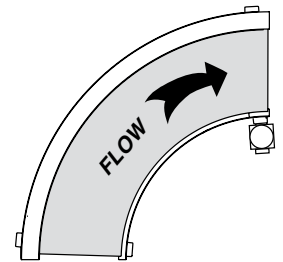

TYPE D
RIGHT HAND CURVE
INSIDE DRIVE

STANDARD

All locations are standard for Transnorm. Specify location.

• OPTIONAL EQUIPMENT

FLOOR SUPPORTS—FSK Type floor supports are available with a wide range of adjustment. Specify top of belt elevation. Supports required at each end and in the center of the conveyor. Holes in feet for lagging to floor. Knee braces recommended above FSK-6 support.

BELT SPEED—Up to 250 FPM (shaft mounted), 251 - 600 FPM (timing belt),

NOTE: Capacity affected with speed change, see chart above. Higher speeds available, contact factory.

DRIVE LOCATION—Specify.

MOTORS—Other HP available, 5 HP maximum (contact factory).

BELTS—Types and styles other than standard are available (contact factory).

CEILING HANGERS—Includes mouting brackets and cross pipes only.

GUARD RAILS—2 in. to 24 in. tall available for all sizes.

ELECTRICAL CONTROLS—Non-reversing magnetic starters and push-button stations. AC variable frequency drive.

CUSTOM COLORS—Available (contact factory). Paint chip must be provided.